

Article number: 25150262002

Description: ICME Single-phase motor MD90 Sb2 1,5KW
2 - 2800 rpm 1x230 Volt 50Hz B3 with starting & running capacitor

Measures

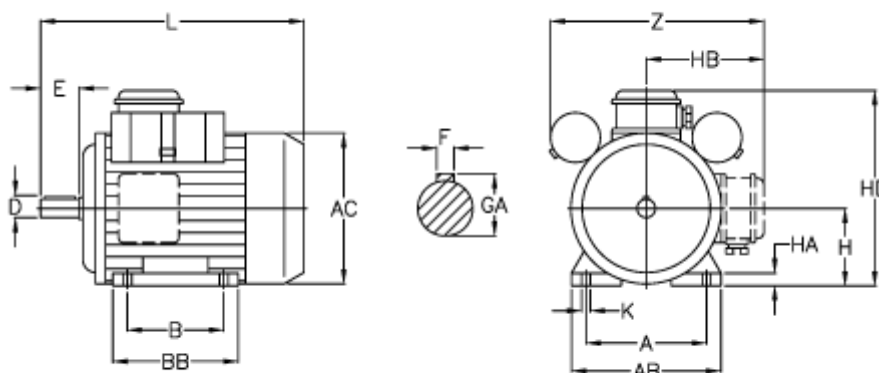

A = 140	H = 90
AB = 184	HA = 14
AC = 176	HB = 129
B = 100	K = 9
D = 24	L = 342
E = 50	Z = 246
F = 8	
GA = 27	